

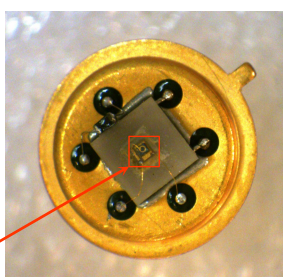

Features

- High reliability
- Spectral Selectivity
- Easy to use in lock-in circuits
- Temperature stabilization



LED chip

Description

Light emitting diode **LED20-TEC** demonstrates typical maximum of emitting wavelength of $\lambda_p = 2.05 \mu\text{m}$ ($I = 150 \text{ mA}$, $f = 0.5 \text{ KHz}$, duty cycle: 50%).

Light emitting diode **LED20-TEC** is equipped with quartz window, thermo-electrical cooler (TEC) and thermistor for stabilizing of temperature.

The components is mounted in a standard 9.2 mm TO-5 package.

LED heterostructure is grown on GaSb substrate.

Related products: **LED20-TEC** can be used in optical pair with our [PD24](#) photodiodes.

Applications

- Measuring equipment
- Gas analysis (CO_2)
- Analytical spectral devices

Options

- Power supply: [LED Driver DLT-27M](#)
- Power supply: [LED Driver DLT-37M](#)

General characteristics

Package	Parameter	Symbol	Value	Unit
TO-5 with TEC	Maximum operating current	I_{QCW}^*	220	mA
		I_{Pulsed}^{**}	2000	
	Soldering temperature	T_s	+ 230	$^{\circ}\text{C}$
	Operating temperature	T_{opr}	- 30...+ 50	$^{\circ}\text{C}$
	Storage temperature	T_{stg}	- 55...+ 60	$^{\circ}\text{C}$
	Weight	m	1.15	g
	Size	D	9.2	mm
H		20.2		

* Quasi-CW mode: Repetition rate: 0.5 kHz, pulse duration: 1 ms, duty cycle: 50%

** Pulse mode: Repetition rate: 0.5 kHz, pulse duration: 2 μs , duty cycle: 0.1%

Electrical and optical characteristics

Parameter	Symbol	Condition	Min	Max	Unit
Peak emission wavelength	λ_p	$I_F = 150 \text{ mA}$	$\lambda_{typ} = 2.05$		μm
			2.02	2.07	
Spectral FWHM	$\Delta\lambda$	$I_F = 150 \text{ mA}$	150	250	nm
Pulse optical power	P^*_{QCW}	$I_F = 200 \text{ mA}$	0.8	1.2	mW
	P^{**}_{Pulsed}	$I_F = 1000 \text{ mA}$	4.4	6.6	
Forward voltage	V_F	(*)	0.5	1.0	V
Switching time	τ		10	30	ns

* Quasi-CW mode: repetition rate: 0.5 kHz, pulse duration: 1 ms, duty cycle: 50%, current: 200 mA

** Pulse mode: repetition rate: 0.5 kHz, pulse duration: 2 μs , duty cycle: 0.1%, current: 1 A

TEC T0506.1MC0400710.TB103 parameters (without load)

Parameter	Symbol	Condition	Value	Unit
Maximum Current	I_{max}	ΔT_{max}	1.50	A
Maximum Voltage	U_{max}	ΔT_{max}	0.80	V
Cooling power	q_{max}	-	1.30	W
Temperature range	ΔT_{max}	vacuum	70	K
Thermistor resistance	R_t	$T = + 20 \text{ }^\circ\text{C}$	10.00	kOhm



Electroluminescence spectra

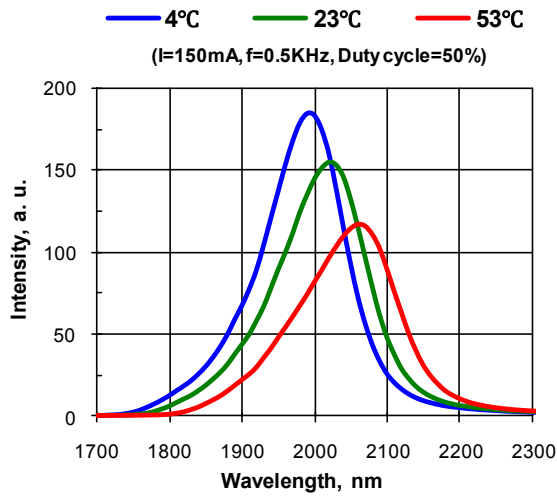

Pulse optical power vs. current

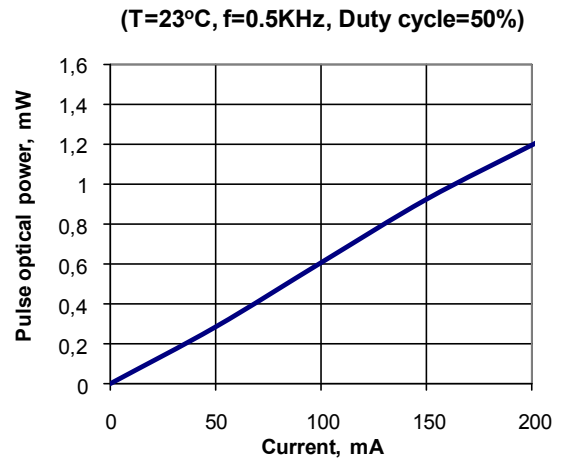

Current vs. voltage

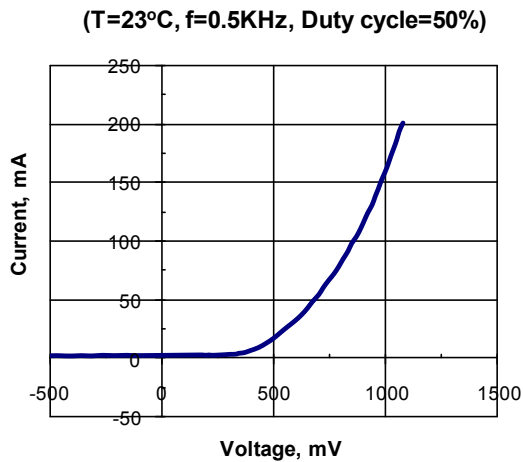

Field pattern

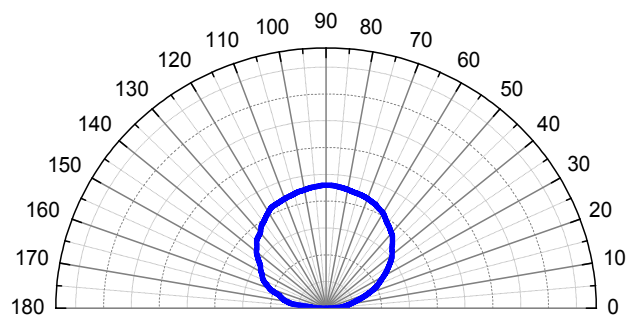

▼ TO-5 package — dimensions (mm)

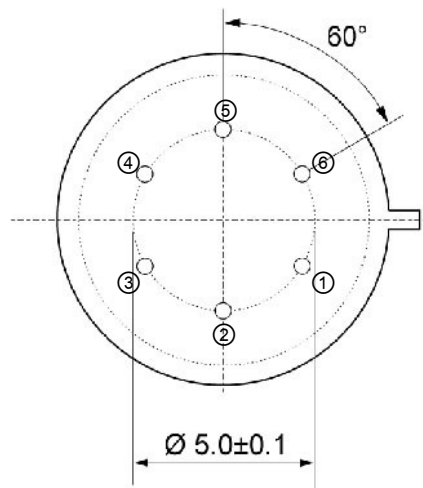
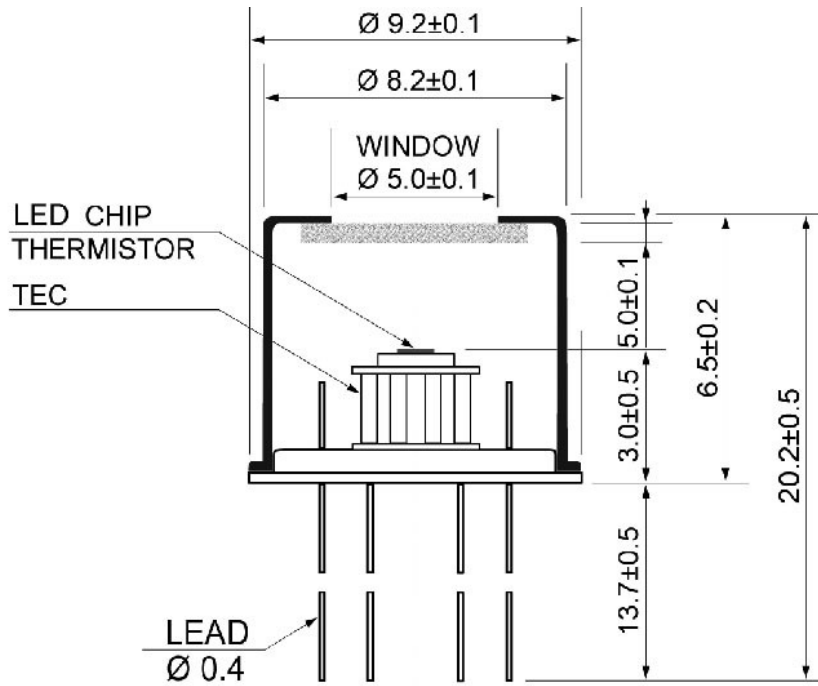

Pin	Description
①	TEC (anode)
②	Diode (anode)*
③	Diode (cathode)*
④	Thermistor TC103
⑤	
⑥	TEC (cathode)

* **Attention:** Pin polarity can be changed on request.