

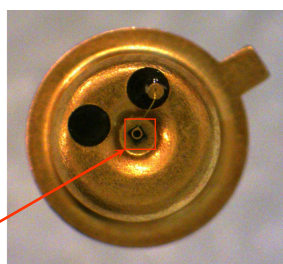

Features

- High reliability
- Spectral Selectivity
- Easy to use in lock-in circuits



LED chip

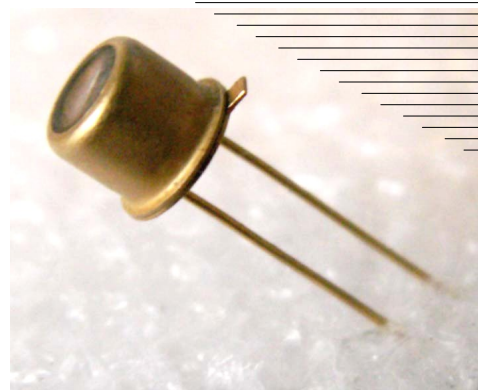

Applications

- Measuring equipment
- Gas analysis (H_2O , H_2S)
- Analytical spectral devices

Options

- Power supply: [LED Driver D-31M](#)

Description

Light emitting diode **LED19** demonstrates typical maximum of emitting wavelength of $\lambda_p = 1.95 \mu\text{m}$ ($I = 150 \text{ mA}$, $f = 0.5 \text{ KHz}$, duty cycle: 50%).

LED chip is mounted in a standard TO-18 package.

LED heterostructure is grown on GaSb substrate.

Related products: **LED19** can be used in optical pair with our [PD24](#) photodiodes.

General characteristics

Package	Parameter	Symbol	Value	Unit
TO-18	Maximum operating current	I^*_{QCW}	220	mA
		I^{**}_{Pulsed}	2000	
	Soldering temperature	T_s	+ 230	$^{\circ}\text{C}$
	Operating temperature	T_{opr}	- 30...+ 50	$^{\circ}\text{C}$
	Storage temperature	T_{stg}	- 55...+ 60	$^{\circ}\text{C}$
	Weight	m	0.26	g
	Size	D	5.5	mm
H		17.7		

* Quasi-CW mode: Repetition rate: 0.5 kHz, pulse duration: 1 ms, duty cycle: 50%

** Pulse mode: Repetition rate: 0.5 kHz, pulse duration: 2 μs , duty cycle: 0.1%

Electrical and optical characteristics

Parameter	Symbol	Condition $T_a \approx +20\text{ }^\circ\text{C}$	Min	Max	Unit
Peak emission wavelength	λ_p	$I_F = 150\text{ mA}$	$\lambda_{typ} = 1.95$		μm
			1.92	1.97	
Spectral FWHM	$\Delta\lambda$	$I_F = 150\text{ mA}$	100	200	nm
Pulse optical power	P^*_{QCW}	$I_F = 200\text{ mA}$	0.8	1.2	mW
	P^{**}_{Pulsed}	$I_F = 1000\text{ mA}$	4.4	6.6	
Forward voltage	V_F	(*)	0.5	1.5	V
Switching time	τ		10	30	ns

* Quasi-CW mode: repetition rate: 0.5 kHz, pulse duration: 1 ms, duty cycle: 50%, current: 200 mA

** Pulse mode: repetition rate: 0.5 kHz, pulse duration: 2 μs , duty cycle: 0.1%, current: 1 A



Electroluminescence spectra

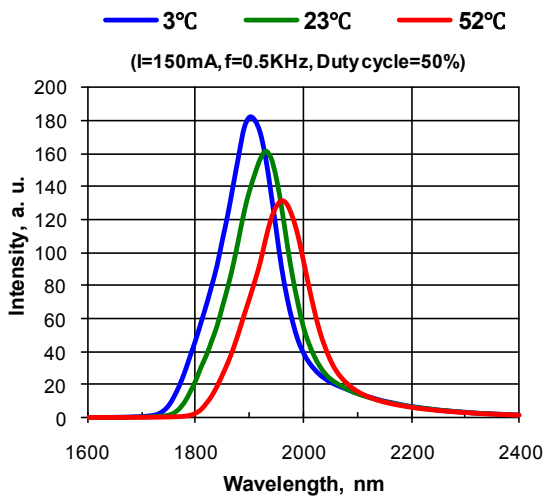

Pulse optical power vs. current

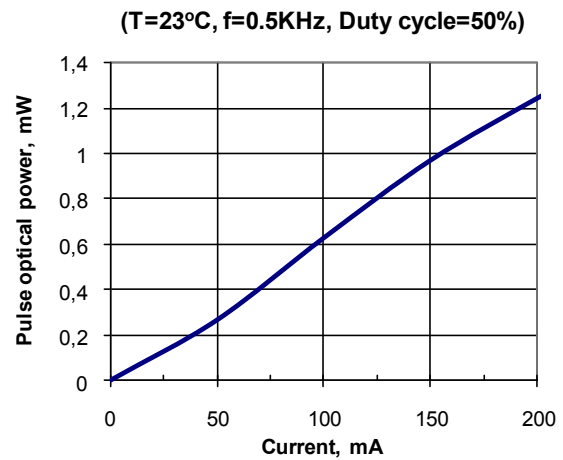

Current vs. voltage

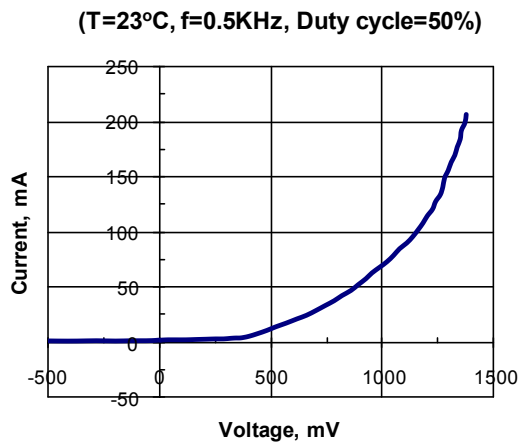

Field pattern

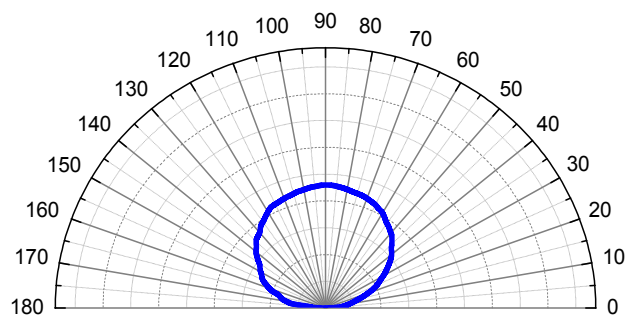

▼ TO-18 package dimensions (mm)

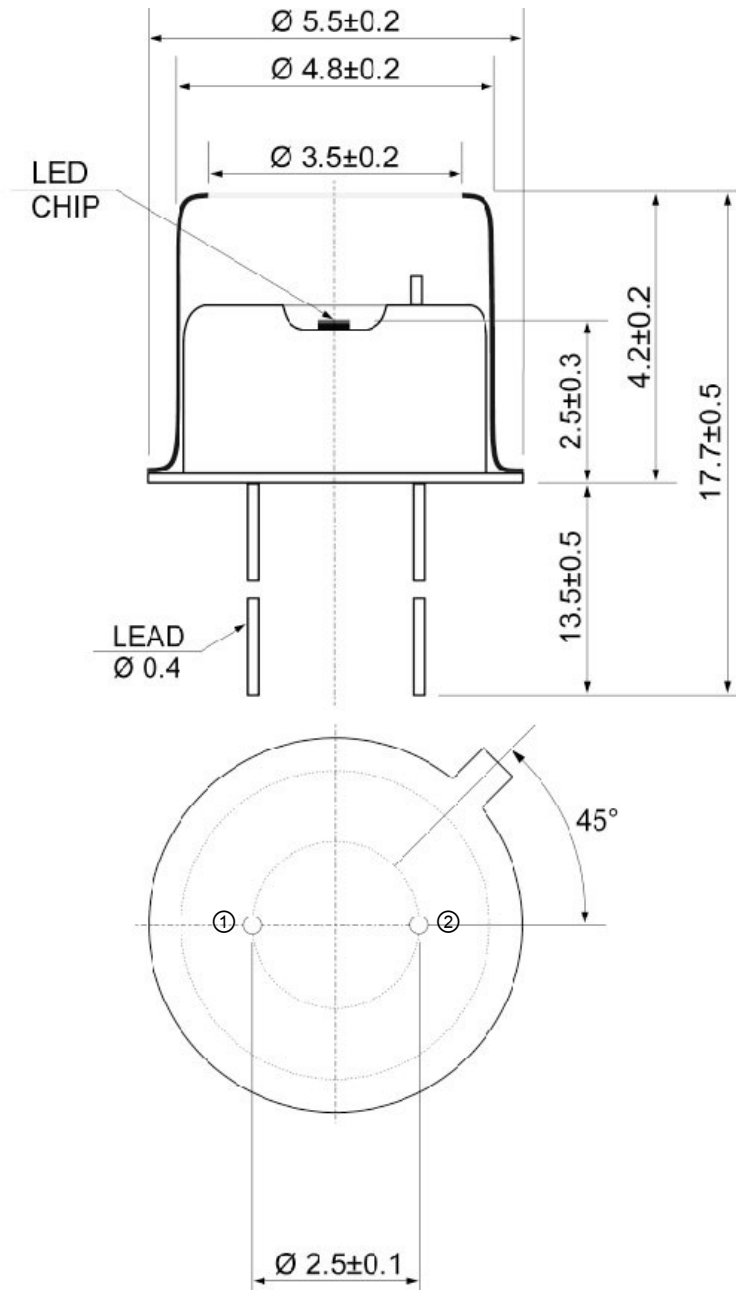

Pin	Description
① Common to case	Diode (cathode)*
②	Diode (anode)*

* **Attention:** Pin polarity can be changed.