



LED405E

Ultra Bright Violet LED

Specifications and Documentation



Part 1. Introduction: LED405E Ultra Bright Violet LED

The [LED405E](#) emits light with a spectral output centered at 405 nm. This LED is composed of heterostructures (HS) grown on an InGaN substrate. The diode is encapsulated in a round clear epoxy casing with a 5 mm diameter.

Part 2. Specifications for an LED405E

2.1. Electrical Specifications

	Typical	Maximum Ratings
Power Dissipation		120 mW
Reverse Voltage		5.0 V
DC Forward Current		30 mA
Forward Voltage @ 20 mA	3.8 V	4.3 V
Reverse Current $V_r = -5$ V		10 μ A
Operating Temperature		-30 °C to 85 °C
Storage temperature Range		-40 °C to 100 °C

Note: All maximum measurements specified are at 25 °C.

2.2. Optical Specifications

	Typical
Center Wavelength	405 nm (± 10 nm)
FWHM	15 nm
Half Viewing Angle	5°
Forward Optical Power	8.4 mW @ 20mA
Total Optical Power	10 mW @ 20mA

2.3. Soldering Specifications

	Conditions
Manual Soldering	295 °C \pm 5 °C , for less than 3 seconds
Wave Soldering	260 °C \pm 5 °C , for less than 5 seconds
Reflow Soldering	Preheating: 70 °C to 80 °C , for 30 seconds Soldering: 245 °C \pm 5 °C , for less than 5 seconds

2.4. Cleaning Solvents

Solvent	Ethyl Alcohol	Isopropyl Alcohol	Propanol	Acetone	Chloroseen	Trichloroethylene	MKS
Approved	Yes	Yes	Yes	No	No	No	No

2.5. Physical Specifications

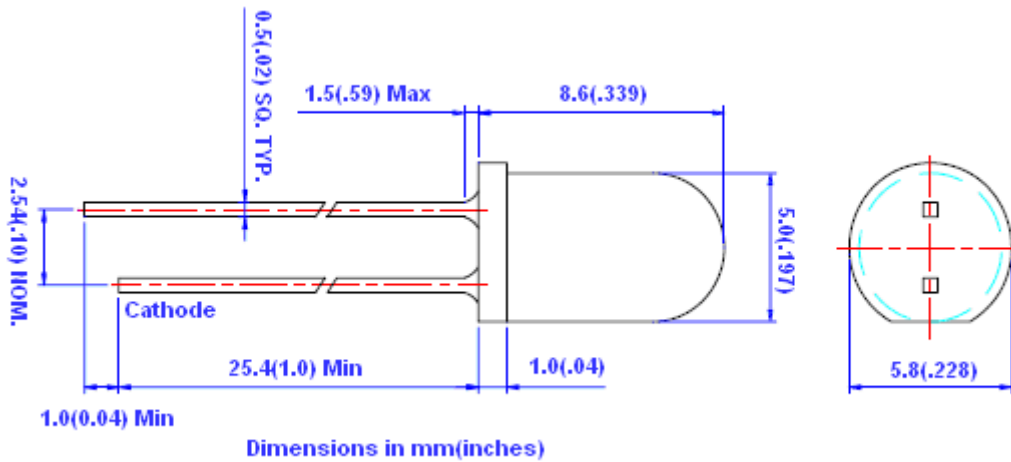
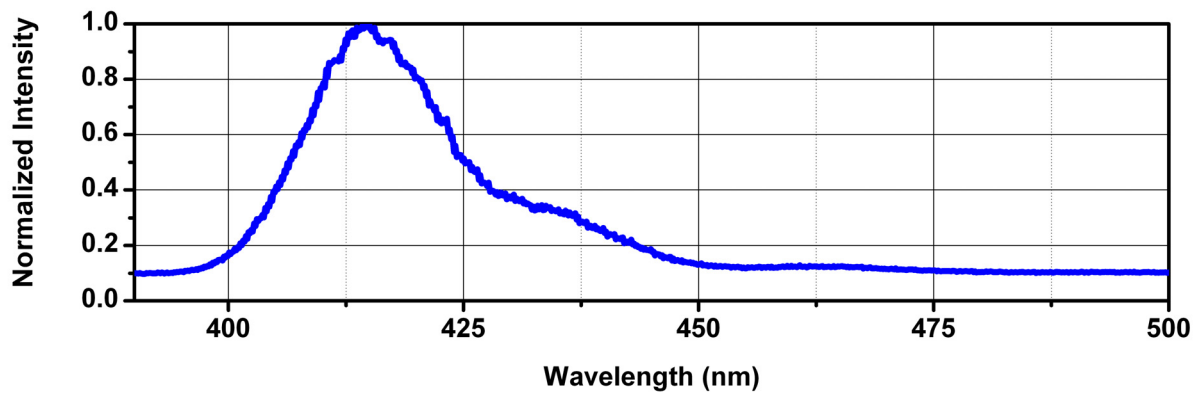
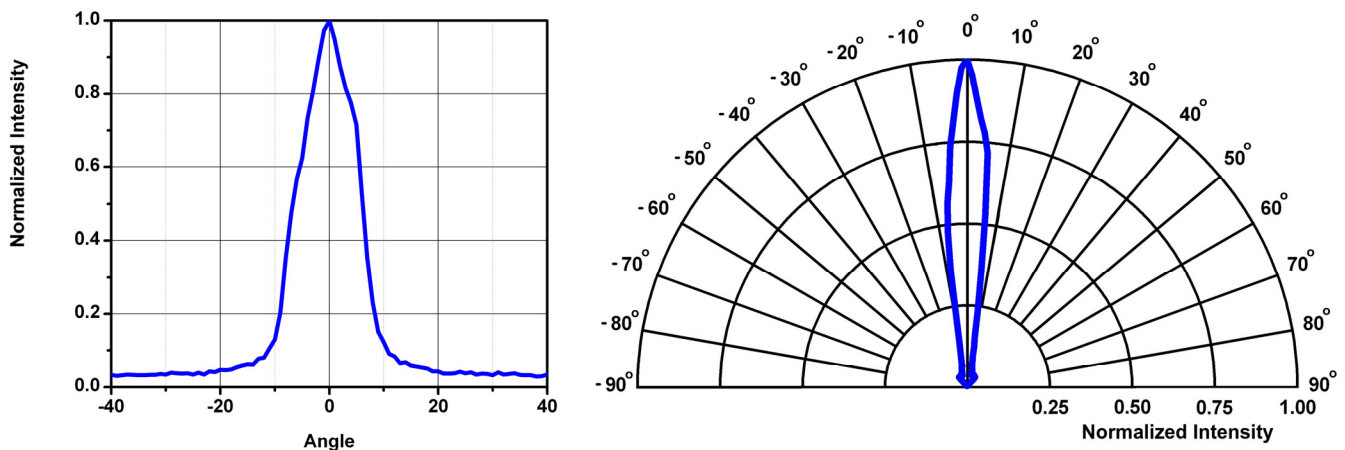

Figure 1: LED401E. The cathode is the short lead and the anode is the long lead.

2.6. Typical Spectral Intensity Distribution



2.7. Typical Radial Intensity Distribution



Part 3. Measurement Techniques

3.1. Measurement Technique for Spectral Distribution Plot and FWHM Specification

A [SP1-USB](#) fiber based spectrometer connected to a computer is used to measure the spectral response of each LED in the visible spectrum (390-810 nm). The LED is powered with a [LD1255](#) laser diode driver operating in a constant current mode. The light from the LED is focused by a Ø1" [Bi-convex lens](#), $f = 40$ mm, into a [multimode fiber](#), 50 μ m SMA patch cable, attached to the spectrometer, see figure 2.

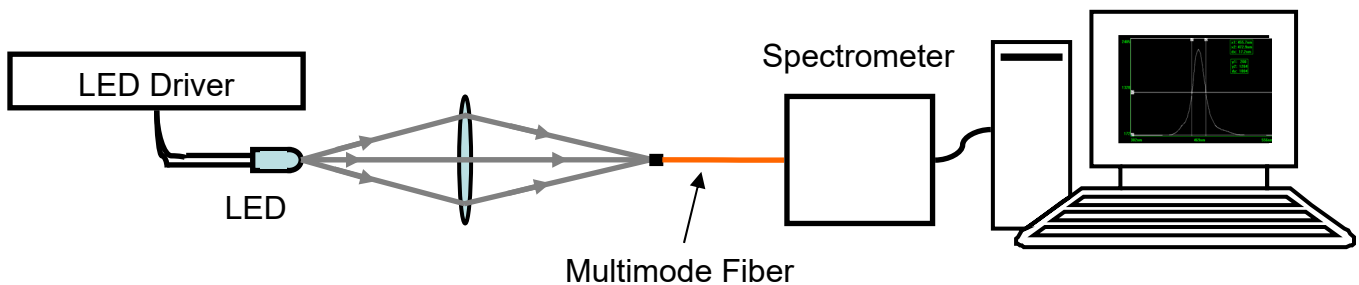

Figure 2: Schematic of the setup used to measure the spectral emission of an LED.

Picture of Setup Depicted in Figure 2



The spectral FWHM is measured using the SP1-USB software; see the screen shot in figure 3. The spectral distribution of the LED is assumed to be Gaussian when determining the FWHM specification. The data is also used to create a typical spectral distribution plot as shown in section 2.5. The central wavelength and shape of the curve vary due to the uniqueness of each LED, as indicated by the deviation column of the optical specifications table.

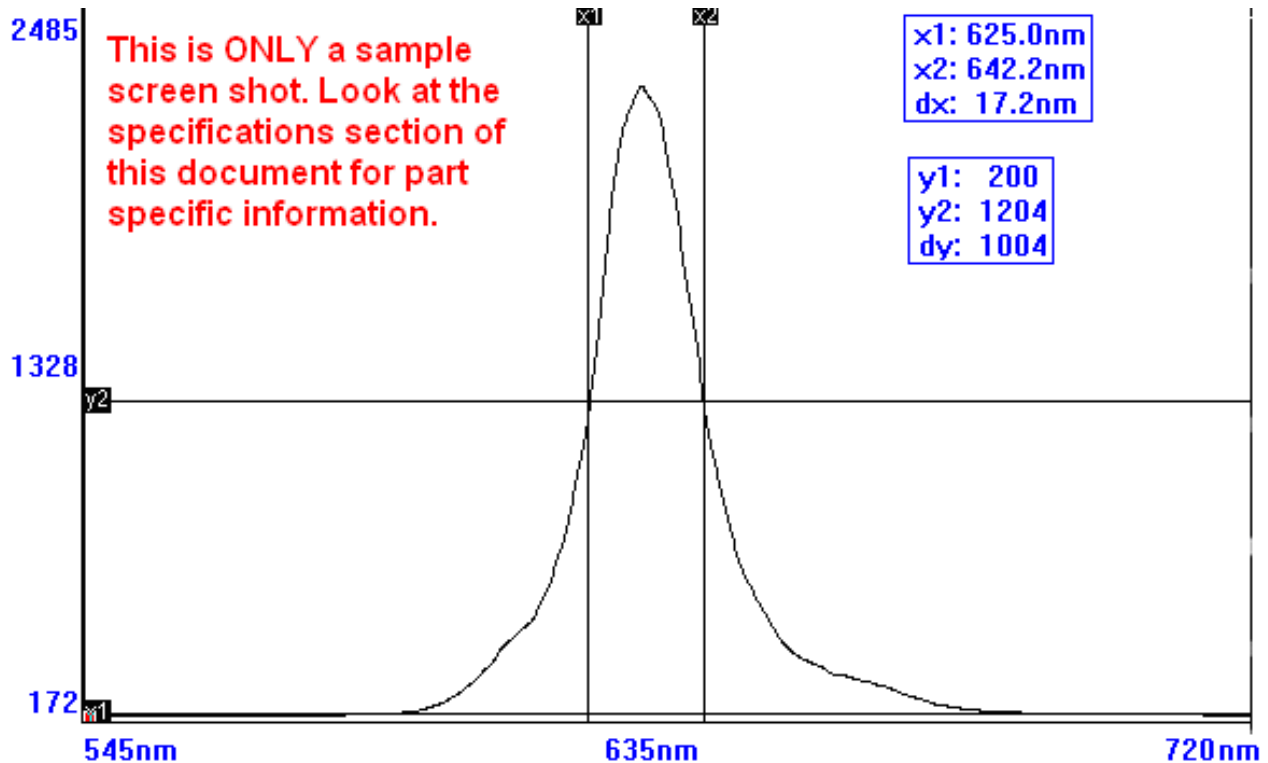

Figure 3: Screen shot of the spectral emission of an LED471E LED measured using an SP1-USB spectrometer.

Part List for Spectral Distribution Measurement

Quantity	Part	Description
1	SP1-USB	400-800 nm USB Spectrometer
1	M14L01	50 um Core SMA Multimode Patch Cable, 0.22 NA
2	UPH2	Swivel Base Post Holder (2")
3	PH2-ST	Post Holder
5	TR1.5	Ø1/2" Posts 1.5" Long
3	BA1	Base Plate
2	LMR1	Lens Mount
1	LMR05	Lens Mount
1	SM1SMA	SM1 to SMA Connector Adapter Plate
1	SM1L05	Lens Tube
1	LB1027-B	Bi-Convex Lens (f = 40 mm)
1	MB810	Solid Standard Aluminum Breadboard (8" x 10")
1	HW-KIT2	1/4-20 Cap Screw Kit
1	LEDMF	LED Socket and Holder

3.2. Measurement Technique for Radial Intensity Distribution Plot and the Half Viewing Angle Specification

To make a measurement of the intensity pattern as a function of angle, the LED is rotated on an axis perpendicular to the axis along which the emitted light intensity was the greatest. Goniometric rotation of the LED is achieved by mounting the LED on a post attached to a motorized rotation stage ([CR1-Z6](#)) so that the rotation axis goes through the light emitting surface of the LED. The CR1-Z6 is powered by an APT [TDC001](#) USB Motor Diver while the LED is powered by an [LD1255](#) Laser Diode Driver. The radiated light is detected using either a Si or InGaAs photodetector, [DET100A](#) or [DET10C](#) respectively, located approximately 12 inches from the LED. To keep stray or scattered light from hitting the detector a \varnothing 1" [lens tube](#) is attached to the detector that extends to just short of the LED. Two [iris](#) apertures are placed along the path from the LED to the detector. The iris closer to the LED has an aperture diameter of 10 mm while the aperture nearest the detector has a diameter of 3 mm. The setup is shown in figure 4.

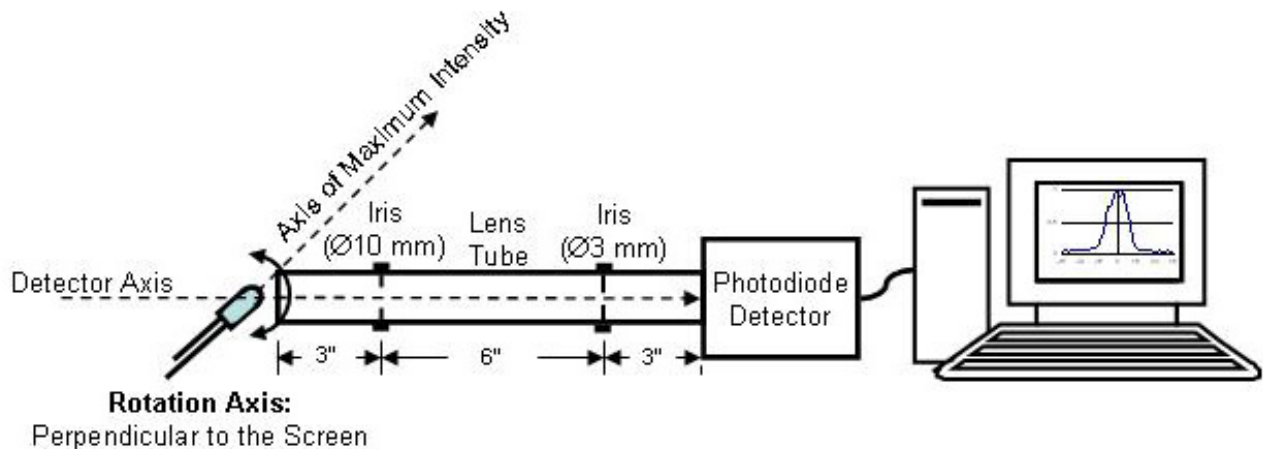

Figure 4: Schematic of the setup used to measure the radial power distribution. The drawing is not to scale.

As the LED rotates, the output of the photodiode detector, which is proportional to the light intensity, is recorded for each angular position using a NI data acquisition card. The LED is rotated from $+90^\circ$ to -90° where 0° approximately corresponds to when the Axis of Maximum Intensity, see figure 5, is parallel to the Detector Axis. The results are displayed in a plot similar to the one shown in figure 6. The half viewing angle specification is determined by the angle that corresponds to a 50% drop in the maximum detector output.



Picture of Setup Depicted in Figure 4

Parts List for Radial Intensity Distribution Measurement

Quantity	Part	Description
1	DET100A or DET10C	Si Photodiode Detector or InGaAs Photodiode Detector
1	CR1-Z6	Motorized Rotational Stage
1	CR1A	CR1 to Post AdapterPlate
1	TDC001	T-Cube Single Channel USB DC Servo Controller/Driver
3	SM1L30	1" Lens Tube 3" Long
2	SM1D12C	SM1 Lever Actuated Iris Diaphragm
2	UPH3	Swivel Base Post Holder
1	PH2-ST	Post Holder
1	PH1-ST	Post Holder
2	TR3	Ø1/2" Post 3" Long
2	TR1	Ø1/2" Post 1" Long
1	RLA0300	Dovetail Optical Rail 3" Long
1	RC1	Rail Carrier
1	MB612	Solid Standard Aluminum Breadboard (6" x 24")
1	2249-C-36	BNC Coaxial Cable
1	HW-KIT2	1/4-20 Cap Screw Kit
1	LEDMF	LED Socket and Holder

*Product in development.

3.3. Measurement Technique for Determining the Forward Radiated Optical Power Specification

The total forward radiated power of the LED is measured using a [PM120](#) with a [S120B](#) Power Head. See the picture below.

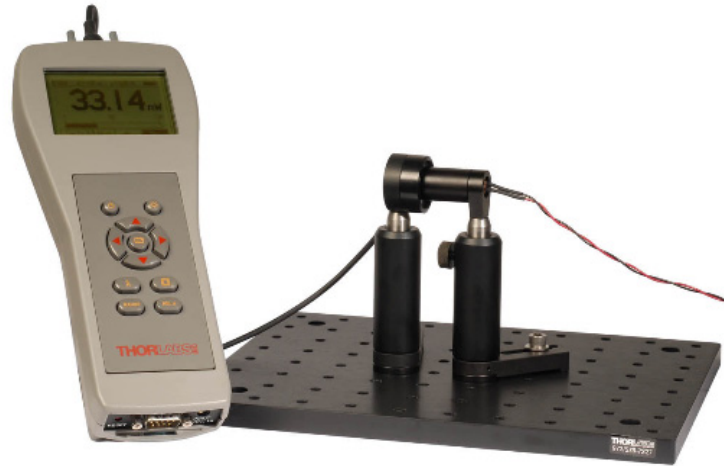

Forward Radiating Power Setup

Parts List for the Forward Radiated Optical Power Measurement

Quantity	Part	Description
1	PM121	Digital Optical Power Meter with S121B optical sensor
2	UPH3	Swivel base post holder 3" Long
2	TR2	Ø1/2" Post 2" Long
1	MB810	Solid Standard Aluminum Breadboard (8" x 10")
1	HW-KIT2	1/4-20 Cap Screw Kit
1	LEDMF	LED Socket and Holder

*Product in development.

3.4. Measurement Technique for Determining the Total Optical Power Specification

The total optical output power of an LED is measured using an integrating sphere. The radiated light is detected using either a Si or InGaAs integrating sphere, [IS236A](#) or [IS210C](#) respectively. The sphere is calibrated with a known laser power source such as the Thorlabs [CPS180](#) laser diode module. The output of the integrating sphere is digitized using our [PDA200C](#) benchtop photodiode amplifier.

Total Radiated Power Setup

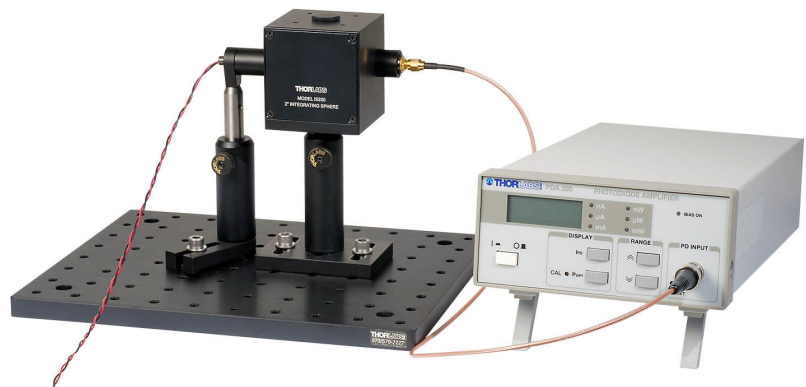

Part List for the Total Radiated Optical Power Measurement

Quantity	Part	Description
1	IS236A or IS210C	2" Integrating Sphere with a Si Detector or 2" Integrating Sphere with a InGaAs Detector
1	PDA200C	Benchtop Photodiode Amplifier
2	UPH3	Swivel Base Post Holder 3" Long
2	TR2	Ø1/2" Post 2" Long
1	HW-KIT2	1/4-20 Cap Screw Kit
1	LEDMF	LED Socket and Holder

*Product in development.

Part 4. Precautions and Warranty Information

These products are ESD (electro static discharge) sensitive and as a result are not covered under warranty. In order to ensure the proper functioning of an LED care must be given to maintain the highest standards of compliance to the maximum electrical specifications when handling such devices. The LEDs are particularly sensitive to any voltage that exceeds the absolute maximum ratings of the product. Any applied voltage in excess of the maximum specification will cause damage and possible complete failure to the product. The user must use handling procedures that prevent any electro static discharges or other voltage surges when handling or using these devices.

Part 5. Contact Information

USA, Canada, and South America
Thorlabs, Inc.
435 Route 206
Newton, NJ 07860
USA
Tel: 973-579-7227
Fax: 973-300-3600
www.thorlabs.com
email: feedback@thorlabs.com

Japan and Asia
Thorlabs Japan Inc.
3-6-3, Kitamachi
Nerima-ku, Tokyo 179-0081
Japan
Tel: 81-3-5977-8401
Fax: 81-3-5977-8402
www.thorlabs.jp
email: sales@thorlabs.jp

Scandinavia
Thorlabs Sweden AB
Box 141 94
400 20 Goteborg
Sweden
Tel: +46-31-733-30-00
Fax: +46-31-703-40-45
www.thorlabs.com
email: scandinavia@thorlabs.com

Europe
Thorlabs GmbH
Hans-Böckler-Str. 6
85221 Dachau
Germany
Tel: +49-(0)8131-5956-0
Fax: +49-(0)8131-5956-99
www.thorlabs.com
email: Europe@thorlabs.com

UK and Ireland
Thorlabs LTD.
1 Saint Thomas Place, Ely
Cambridgeshire CB7 4EX
Great Britain
Tel: +44 (0)1353-654440
Fax: +44 (0)1353-654444
www.thorlabs.com
email: sales.uk@thorlabs.com